

| TPA/TPVD    | Wat  | B   | A    | C   | D    |
|-------------|------|-----|------|-----|------|
| TPA/TPVD 04 | 400  | 116 | 202  | 185 | 503  |
| TPA/TPVD 06 | 600  | 163 | 302  | 186 | 651  |
| TPA/TPVD 08 | 800  | 253 | 302  | 258 | 813  |
| TPA/TPVD 10 | 1000 | 185 | 605  | 185 | 975  |
| TPA 12      | 1200 | 230 | 605  | 230 | 1065 |
| TPA 15      | 1500 | 375 | 605  | 375 | 1355 |
| TPA 20      | 2000 | 230 | 1198 | 241 | 1669 |

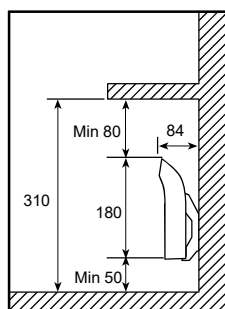

| TLO    | Wat  | B   | A    | C   | D    |
|--------|------|-----|------|-----|------|
| TLO 03 | 250  | 105 | 202  | 177 | 484  |
| TLO 05 | 500  | 252 | 302  | 250 | 803  |
| TLO 07 | 750  | 219 | 605  | 225 | 1049 |
| TLO 10 | 1000 | 409 | 605  | 415 | 1429 |
| TLO 14 | 1400 | 275 | 1198 | 270 | 1743 |

| TPA60/TPVD60    | Wat  | B   | A    | C   | D    |
|-----------------|------|-----|------|-----|------|
| TPA60/TPVD60 04 | 400  | 253 | 302  | 258 | 813  |
| TPA60/TPVD60 06 | 600  | 230 | 605  | 230 | 1065 |
| TPA60/TPVD60 08 | 800  | 230 | 1198 | 241 | 1669 |
| TPA60/TPVD60 10 | 1000 | 230 | 1198 | 241 | 1669 |

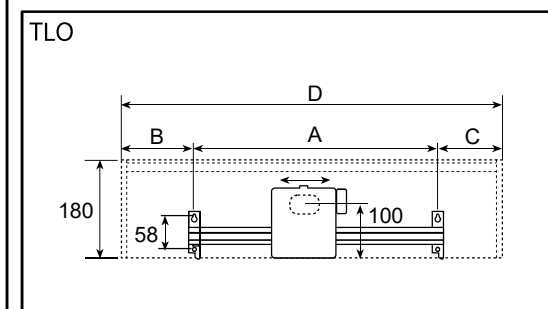
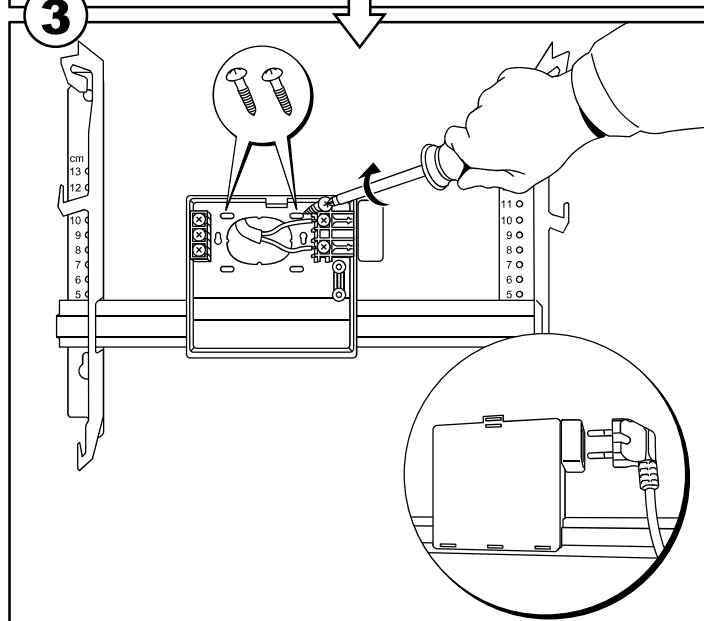
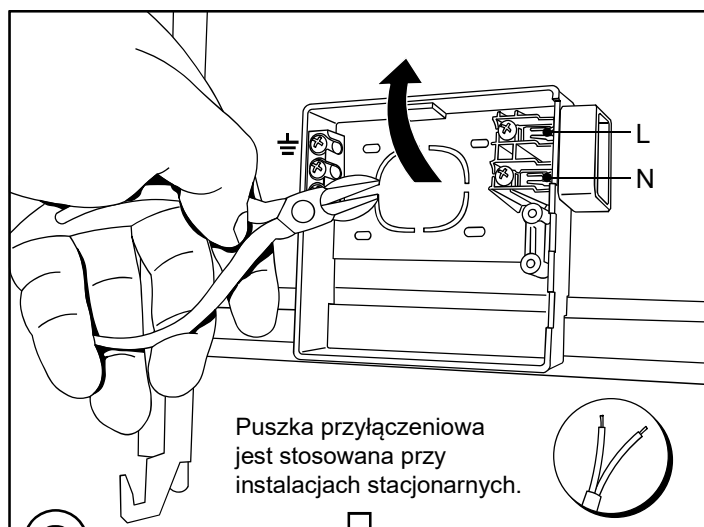
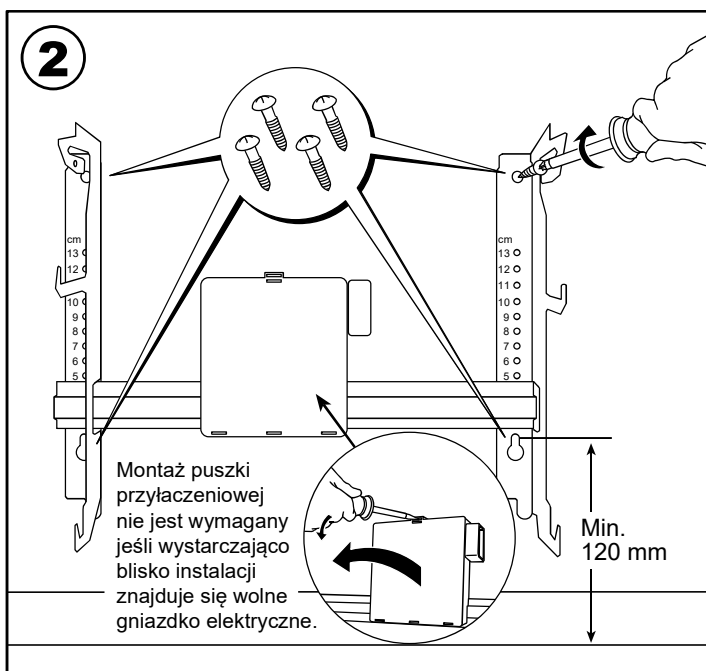
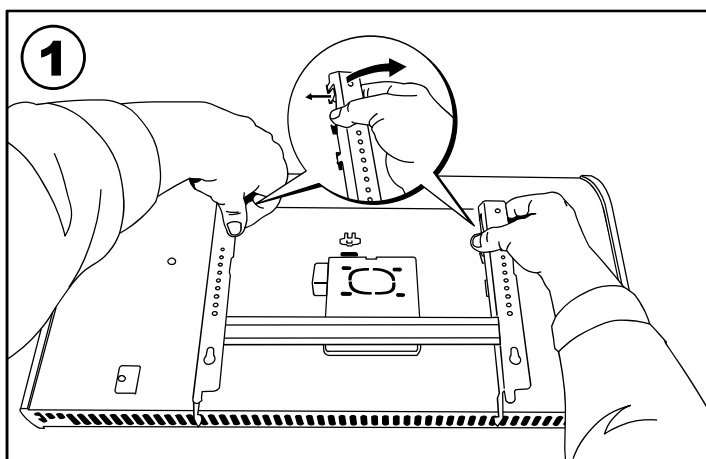

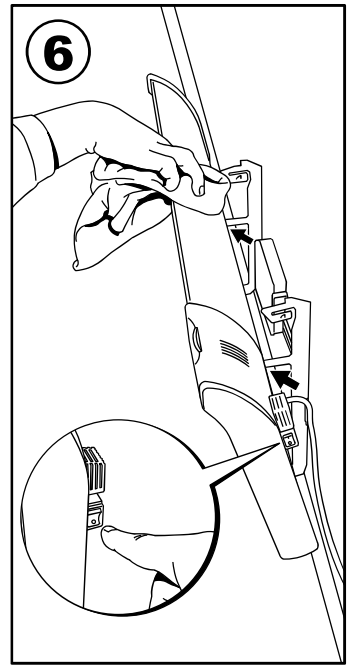
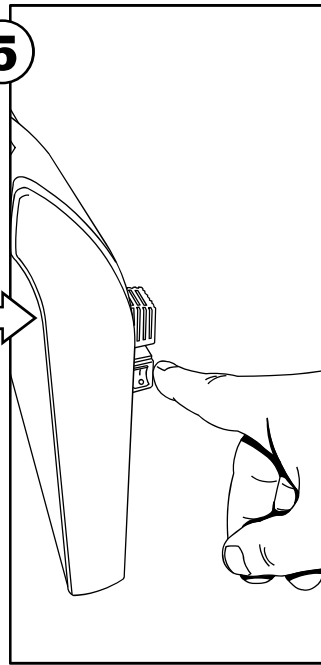
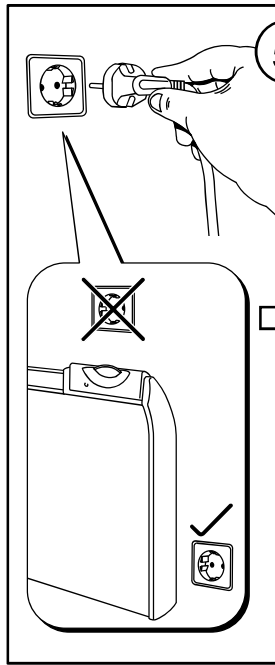
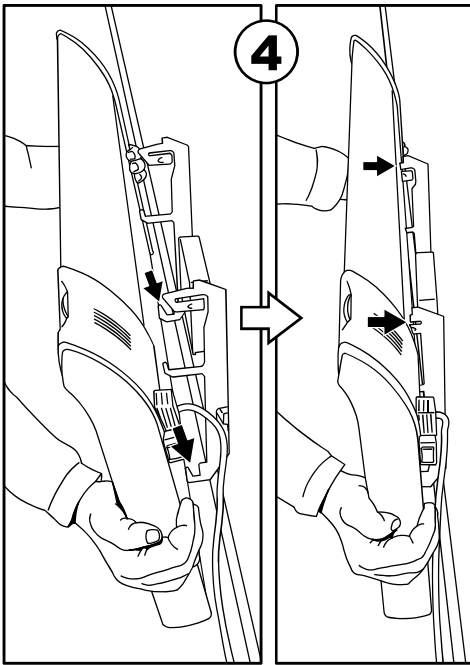

230 woltowy wykres

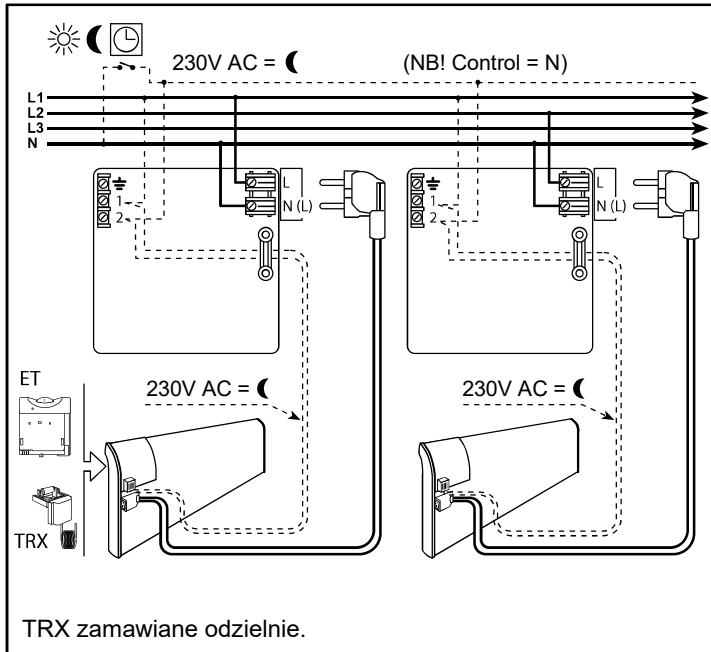

230 woltowy wykres

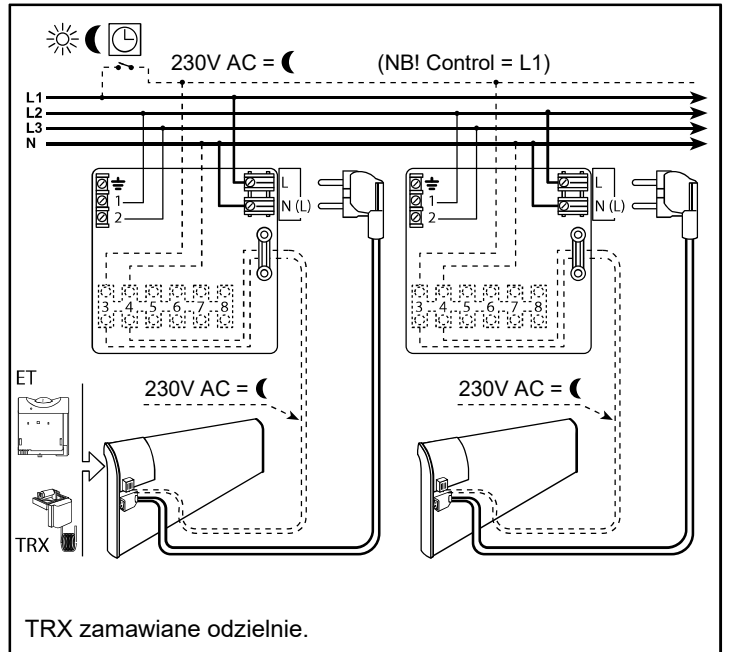

400 woltowy wykres

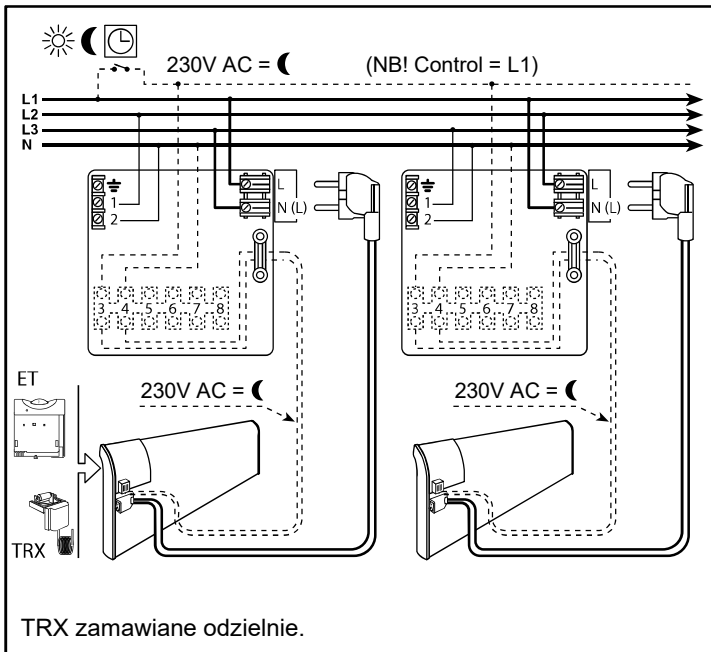

**KONTAKT**

+48 22 219 71 99  
 +48 500 111 694  
 glamox@glamox.pl  
 www.glamox.pl

